

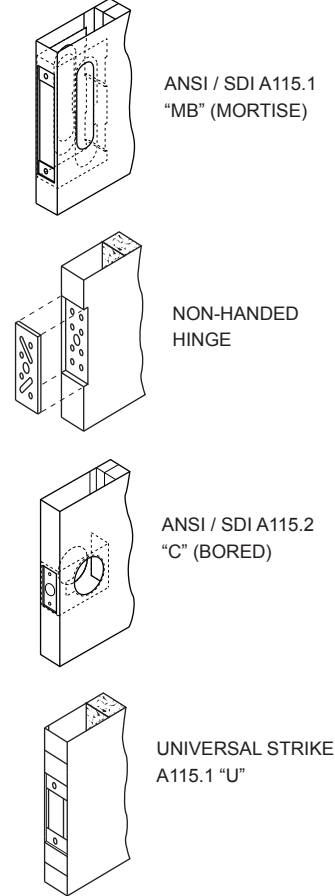

**Standard Features**

- ◆ 16-Gauge Cold Rolled or Galvanized Steel
- ◆ Seamless Filled Edges
- ◆ Full Body Polystyrene Core
- ◆ Non- Handed Design
- ◆ 12-Gauge Closer Reinforcement
- ◆ 7-Gauge Hinge Reinforcement- Reversible
- ◆ 16-Gauge Flush Top Cap - Galvanized Standard / Heavy Duty
- ◆ 16-Gauge Inverted Bottom Cap - Galvanized
- ◆ Prime Painted Grey Two Part Epoxy Factory Applied, Baked On
- ◆ Standard Lock Preparations Include 161, Fed 86 Edge, Panic Bar Reinforced
- ◆ WHI / ITS up to 3 hour, Positive Pressure and "S" Smoke included
- ◆ Meets or Exceeds Standards for ANSI 250.4 and ANSI 250.8

**Typical Hardware Preparations**



**Sections**

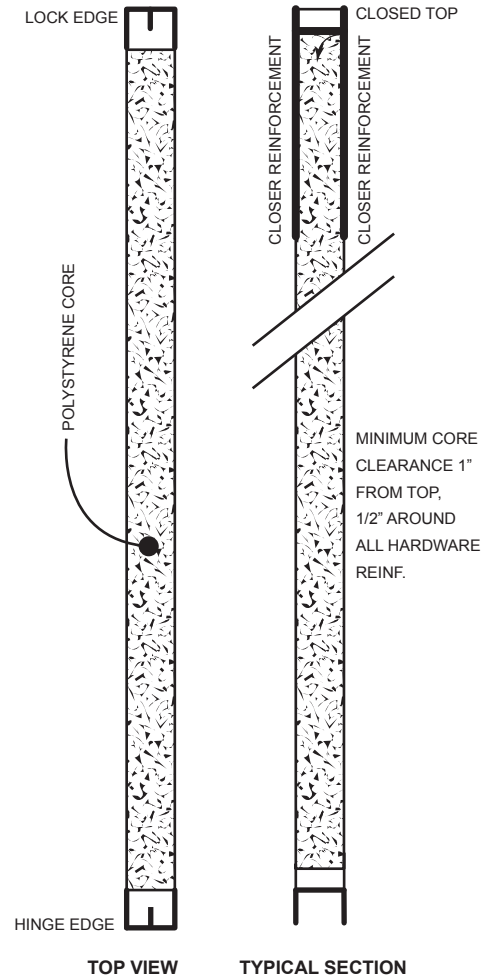

F

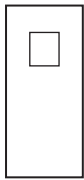

V  
10 x 10

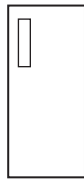

N  
5 x 20

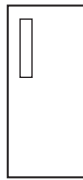

N  
4 x 25



N  
3 x 33

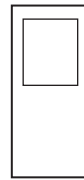

HG

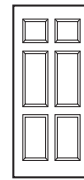

1700

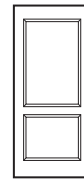

1900



1900

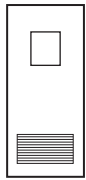

VLI



N5LI

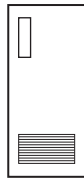

N4LI

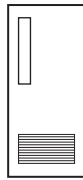

N3LI

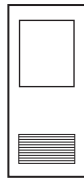

GLI



LI

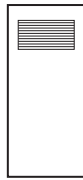

TLI

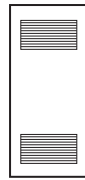

L2

